

ISTRUZIONI PER L'INSTALLAZIONE
INSTALLATION INSTRUCTIONS
INSTALLATIONSANLEITUNG
INSTRUCTIONS POUR L'INSTALLATION
INSTRUCCIONES PARA LA INSTALACIÓN

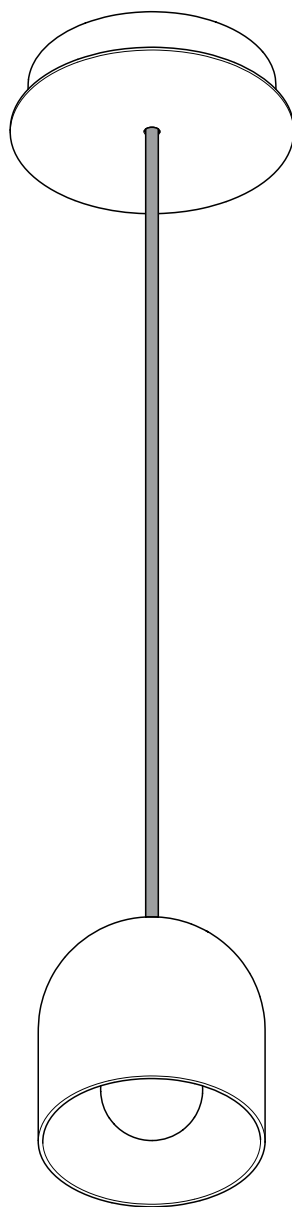

Flippino

CE IP20 

CINI & NILS

Caratteristiche di sicurezza

Apparecchio a LED costruito secondo le norme europee di sicurezza EN60598-1 e i criteri della classe II che non richiedono la messa a terra. La sicurezza è garantita solo se l'apparecchio viene installato e usato in modo appropriato in base alle relative istruzioni. Queste istruzioni devono essere conservate con cura per ogni ulteriore consultazione.

Avvertenze

Il corretto funzionamento e la durata dei componenti elettronici e dei led è garantito solo in presenza di:
- impianto elettrico certificato ed esente da picchi di tensione.
- cablaggi e dispositivi (interruttori, prese, dimmer, eccetera) in perfetto stato.

Apparecchio da installare con tensione disattivata dal quadro generale. Prima di qualunque intervento togliere tensione all'apparecchio: rischio di scossa elettrica.

Apparecchio adatto solo per uso in interni.

Sorgente luminosa E14 inclusa e sostituibile dall'utilizzatore finale. In caso di sostituzione utilizzare sorgente luminosa con caratteristiche simili.

Questo prodotto contiene una sorgente luminosa di classe di efficienza energetica E.

L'apparecchio non deve, in alcuna circostanza, essere coperto con materiale isolante o similari.

Le operazioni di pulizia vanno eseguite con un panno asciutto, non utilizzare alcun tipo di detergente.

Utilizzare solo parti di ricambio originali.

È assolutamente vietato smontare o manomettere l'apparecchio, nel caso in cui si verificassero situazioni anomale spegnere immediatamente e contattare il rivenditore o il servizio post vendita Cini&Nils.

Cini&Nils declina ogni responsabilità derivante da manutenzione e/o smontaggio dell'apparecchio eseguito da personale non autorizzato.

Dimmerazione

Apparecchio regolabile solo con dimmer per led a taglio di fase "trailing edge" con livello minimo regolabile. Leggeri ronzii sono fisiologici della dimmerazione a taglio di fase. Leggere attentamente le istruzioni di installazione del dimmer.

Safety features

LED luminaire, constructed in compliance with the European safety standard EN60598-1 and the criteria of class II, which do not require any earth connections. Safety is guaranteed only if the fitting is used correctly, in accordance with the relevant instructions. Keep these instructions carefully for future reference.

Warning

The electric components and LEDs are guaranteed to function correctly only when:
- the wiring system is certified and free of voltage surges.
- the wiring and devices (switches, sockets, dimmers etc.) are in perfect condition.

Always cut the power from the mains before any installation or other work. Cut off the power to the fitting before doing any work: electric shock hazard.

This fitting is suitable for indoor installation only.

Light source E14 included and replaceable by the end user. In case of replacement, use a light source with similar characteristics.

This product contains a Class E energy efficiency light source.

The light fitting must never, under any circumstances, be covered with insulating or similar materials.

Clean with a dry cloth, do not use any detergent.

Use only original spare parts.

Never dismantle or tamper with the device under any circumstances. In case of anomaly, switch it off immediately and contact your retailer or the Cini&Nils after-sales service.

Cini&Nils cannot accept responsibility pursuant to any tampering with the device and/or dismantling it if this is undertaken by anyone without the necessary authorisation.

Dimming

Fitting adjustable only with a dimmer for trailing-edge phase-cutting LED with adjustable minimum level. A slight buzzing sound is normal in a phase-cutting dimmer system. Read the dimmer installation instructions carefully.

Sicherheitsmerkmale

LED-Leuchte ist im Einklang mit der europäischen Sicherheitsnorm EN60598-1 und den Anforderungen der Gerätekategorie II (keine Erdung erforderlich) hergestellt. Die Betriebssicherheit der Leuchte ist jedoch nur bei sachgerechtem Einbau und Gebrauch gemäß Anweisungen gewährleistet. Bewahren Sie alle Anweisungen zur späteren Einsichtnahme sorgfältig auf.

Warnhinweise

Die sachgerechte Funktion und Lebensdauer der elektronischen Bauelemente und Leuchtdioden ist nur unter folgenden Bedingungen gewährleistet:
- zertifizierte Elektroanlage ohne Spannungsspitzen.
- Verdrahtung und Anlagenteile (Schalter, Steckdosen, Dimmer usw.) in einwandfreiem Zustand.

Vor der Installation und vor jeglichen anderen Arbeiten stets die Stromzufuhr beim Sicherungskasten unterbrechen. Vor jeglichen Arbeiten an den Leuchten ist stets die Stromzufuhr zu unterbrechen: Gefahr eines elektrischen Schlages.

Leuchten nur zum Gebrauch in Innenräumen geeignet.

Lichtquelle E14 enthalten und vom Endverbraucher austauschbar. Verwenden Sie im Falle eines Austauschs eine Lichtquelle mit ähnlichen Eigenschaften.

Dieses Produkt enthält eine Lichtquelle der Energieeffizienzklasse E.

Das Gerät darf nie mit Isoliermaterial oder ähnlichem bedeckt werden.

Mit einem trockenen Tuch reinigen. Keine Reinigungsmittel verwenden.

Verwenden Sie nur Original-Ersatzteile.

Die Leuchte darf unter keinen Umständen auseinandergebaut oder verändert werden; bei ungewöhnlichem Verhalten sofort abschalten und den Händler oder den Cini&Nils Kundendienst kontaktieren.

Cini&Nils schließt bei Eingriffen durch Unbefugte und/oder Änderungen an der Leuchte jede Haftung aus. Die Leuchte von Wärmequellen fernhalten.

Dimmen

Die Lichtstärke ist nur mit einem Phasenabschnitts-LED-Dimmer (mit einstellbarer Mindeststufe) regulierbar. Ein leichtes Brummgeräusch ist bei Phasenabschnittsdimmern normal. Die Installationsanleitung des Dimmers genau befolgen.

Caractéristiques de sécurité

Appareil à LED, construit conformément aux normes de sécurité européennes EN60598-1 et aux critères de la classe II, qui ne nécessitent pas de mise à la terre. La sécurité est garantie seulement si l'appareil est installé et utilisé de façon appropriée conformément aux instructions. Conserver avec soin ces instructions pour toute consultation ultérieure.

Avvertissements

Le fonctionnement correct et la durée des composants électroniques et des led est garanti seulement en présence de:
- une installation électrique certifiée et exempte de pics de tension.
- des câblages et des dispositifs, (interrupteurs, prises, dimmers, etc.), en parfait état.

Avant toute installation et intervention, couper le courant au tableau général. Couper le courant avant toute intervention sur l'appareil: risque de choc électrique.

Appareils aptes pour un usage en intérieurs seulement.

Source lumineuse E14 incluse et remplaçable par l'utilisateur final. En cas de remplacement, utilisez une source lumineuse aux caractéristiques similaires.

Ce produit contient une source lumineuse de classe d'efficacité énergétique E.

L'appareil ne doit en aucun cas être recouvert par du matériel isolant ou similaire.

Il faut exécuter les opérations de nettoyage avec un chiffon sec; n'utiliser pas aucun détergent.

Utilisez uniquement des pièces de rechange d'origine.

L'appareil ne doit absolument pas être démonté, ni modifié. En cas d'anomalie, éteignez-le immédiatement et contactez le revendeur ou le service après-vente de Cini&Nils.

Cini&Nils décline toute responsabilité en cas de manipulation et/ou de démontage de l'appareil effectué par du personnel non autorisé.

Dimmeration

Appareil réglable uniquement avec gradateur pour LED à découpage de phase "trailing edge" avec niveau minimal réglable. De légers bourdonnements sont physiologiques de la variation à découpage de phase. Lisez attentivement les instructions d'installation du gradateur.

Características de seguridad

Aparato de LED, fabricado según las normas europeas de seguridad EN60598-1 y los criterios de la clase II que no necesitan la puesta a tierra. La seguridad se garantiza sólo si el aparato se instala y se usa de manera apropiada siguiendo las instrucciones correspondientes. Conservar cuidadosamente estas instrucciones para futuras consultas.

Advertencias

El correcto funcionamiento y la duración de los componentes electrónicos y de los leds están garantizados únicamente si:
- la instalación eléctrica está certificada y no está sujeta a picos de tensión.
- el cableado y los dispositivos (interruptores, tomas, dimmers, etc.) están en perfecto estado.

Antes de realizar cualquier operación cortar la alimentación eléctrica del aparato. Antes de realizar cualquier operación cortar la alimentación eléctrica del aparato: riesgo de descarga eléctrica.

Aparatos indicados exclusivamente para uso en interiores.

Fuente de luz E14 incluida y reemplazable por el consumidor final. En caso de sustitución, utilice una fuente de luz de características similares.

Este producto contiene una fuente de luz de clase de eficiencia energética E.

El aparato no debe, en ningún caso, cubrirse con material aislante o similares.

Las operaciones de limpieza deben realizarse con un paño seco, sin usar ningún tipo de detergente.





Use solo repuestos originales.

Está absolutamente prohibido desmontar o manipular el aparato. Si se verificaran situaciones anómalas, apagarlo inmediatamente y contactar con el revendedor o con el servicio postventa de Cini&Nils.



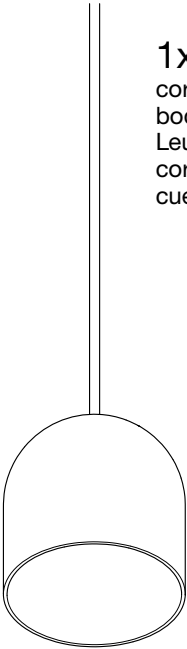
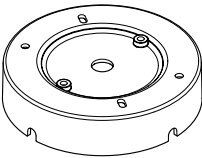

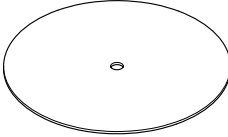

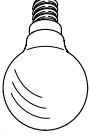
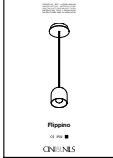

Cini&Nils declina toda responsabilidad derivada de la manipulación y/o desmontaje del aparato realizado por personal no autorizado.

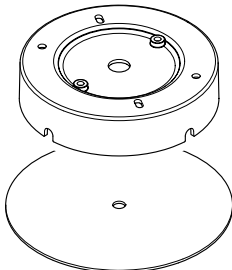
Regulación

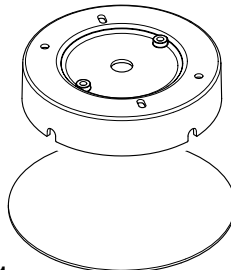
Aparato regulable sólo con regulador de luz para led con corte de fase "trailing edge" con nivel mínimo regulable. Leves zumbidos son fisiológicos de la regulación de luz con corte de fase. Leer atentamente las instrucciones de instalación del regulador de intensidad de luz.

| | | | |
|---|--|---|--|
|  <p>1x corpo della lampada body of the lamp Leuchtenkörper corps de la lampe cuerpo de la lámpara</p> <p>Flippino</p> |  <p>1x rosone rose Rosette rosette florón</p> |  <p>1x chiave spanner Schlüssel clef llave</p> | |
| |  <p>1x disco rosone per uscite cavo centrale e laterali rose disc for central and side cable outlets Rosettenscheibe für zentralen und seitlichen Kabelabgang disque rosette pour sorties de câble centrale et latérales disco de florón para salidas de cable central y laterales</p> |  <p>4x tassello rawlplug Dübel cheville taco</p> |  <p>4x vite screw Schraube vis tornillo</p> |
| | |  <p>1x lampadina lamp Leuchte lampe lámpara</p> |  <p>istruzioni instructions Montageanleitung instructions instrucciones</p> |

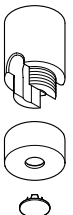
ACCESSORI (non inclusi) - ACCESSORIES (not included) - ZUBEHÖR (nicht enthalten) - ACCESSOIRES (non inclus) - ACCESORIOS (no incluido)

| | | | |
|--|--|--|--|
| <p>CB15201W - RAL 9003 Bianco-White-Weiss-Blanc-Blanco CB15201B - RAL 9005 Nero-Black-Schwarz-Noir-Negro</p>  <p>1x rosone rose Rosette rosette florón</p> <p>1x disco rosone per uscite cavo centrale e laterali rose disc for central and side cable outlets Rosettenscheibe für zentralen und seitlichen Kabelabgang disque rosette pour sorties de câble centrale et latérales disco de florón para salidas de cable central y laterales</p>  <p>4x tassello rawlplug Dübel cheville taco</p>  <p>4x vite screw Schraube vis tornillo</p> | <p>CB15202W - RAL 9003 Bianco-White-Weiss-Blanc-Blanco CB15202B - RAL 9005 Nero-Black-Schwarz-Noir-Negro</p>  <p>1x rosone rose Rosette rosette florón</p> <p>1x disco rosone per uscite laterali rose disc for side exits Rosettenscheibe für seitliche Ausgänge disque rosette pour sorties latérales disco de florón para salidas laterales</p>  <p>4x tassello rawlplug Dübel cheville taco</p>  <p>4x vite screw Schraube vis tornillo</p> | <p>CB152032 2700k CB152033 3000k CB15203N 4000k</p>  | <p>CB15200B RAL 9005 Nero-Black- Schwarz- Noir-Negro</p>  <p>1x decentratore decentering unit Dezentralverteiler décentralisateur descentrador</p>  <p>1x tassello rawlplug Dübel cheville taco</p>  <p>1x vite screw Schraube vis tornillo</p> |
|--|--|--|--|

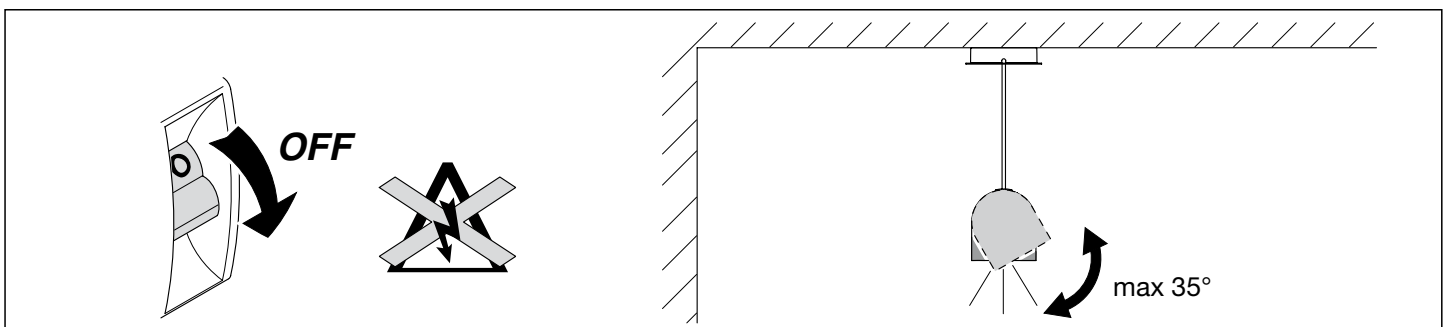

MONTAGGIO ROSONE - ROSE ASSEMBLY - ROSETTENMONTAGE - MONTAGE DE ROSETTE - MONTAJE DE FLORÓN

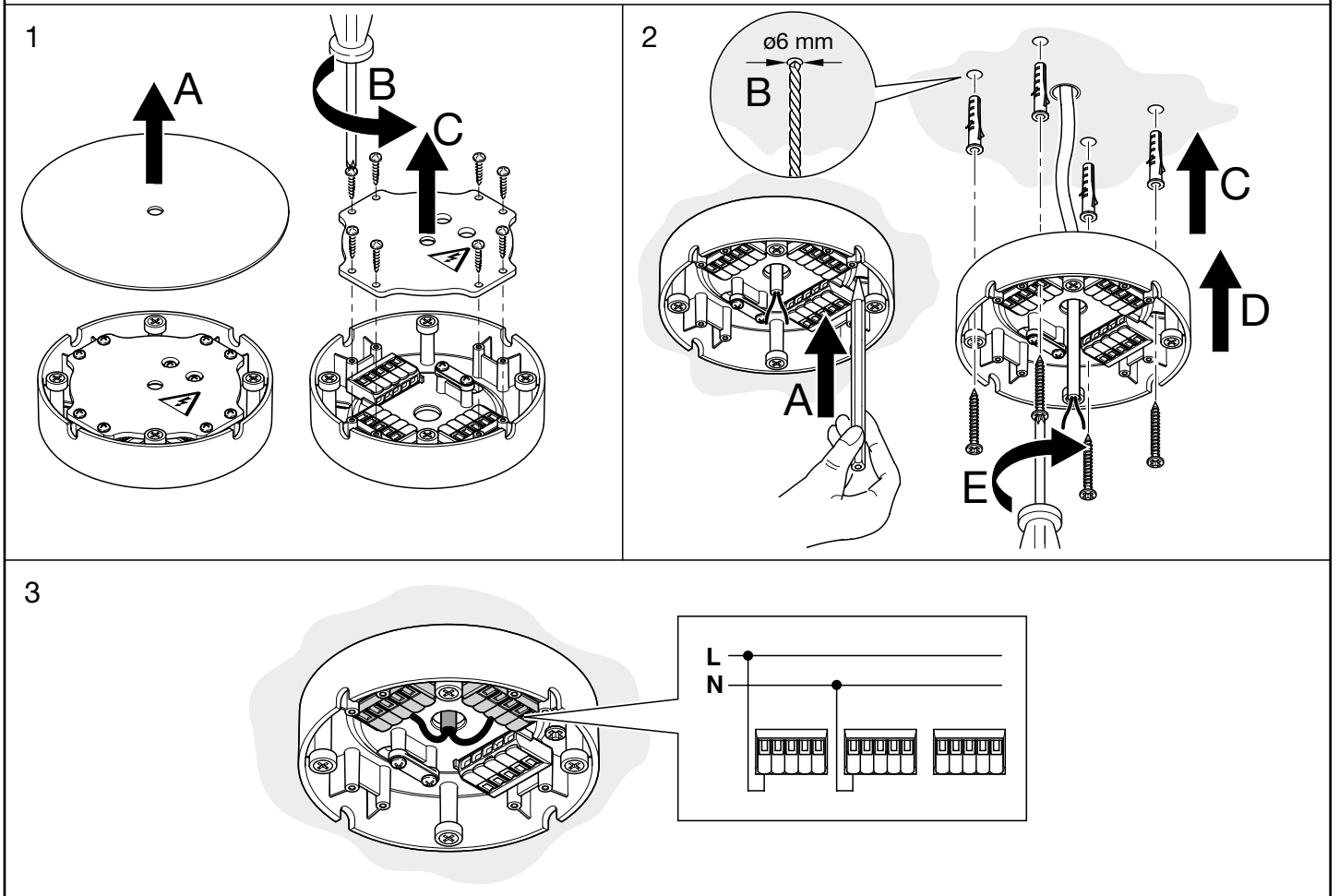

REGOLAZIONE - ADJUSTMENT - EINSTELLUNG - AJUSTEMENT - AJUSTAMIENTO

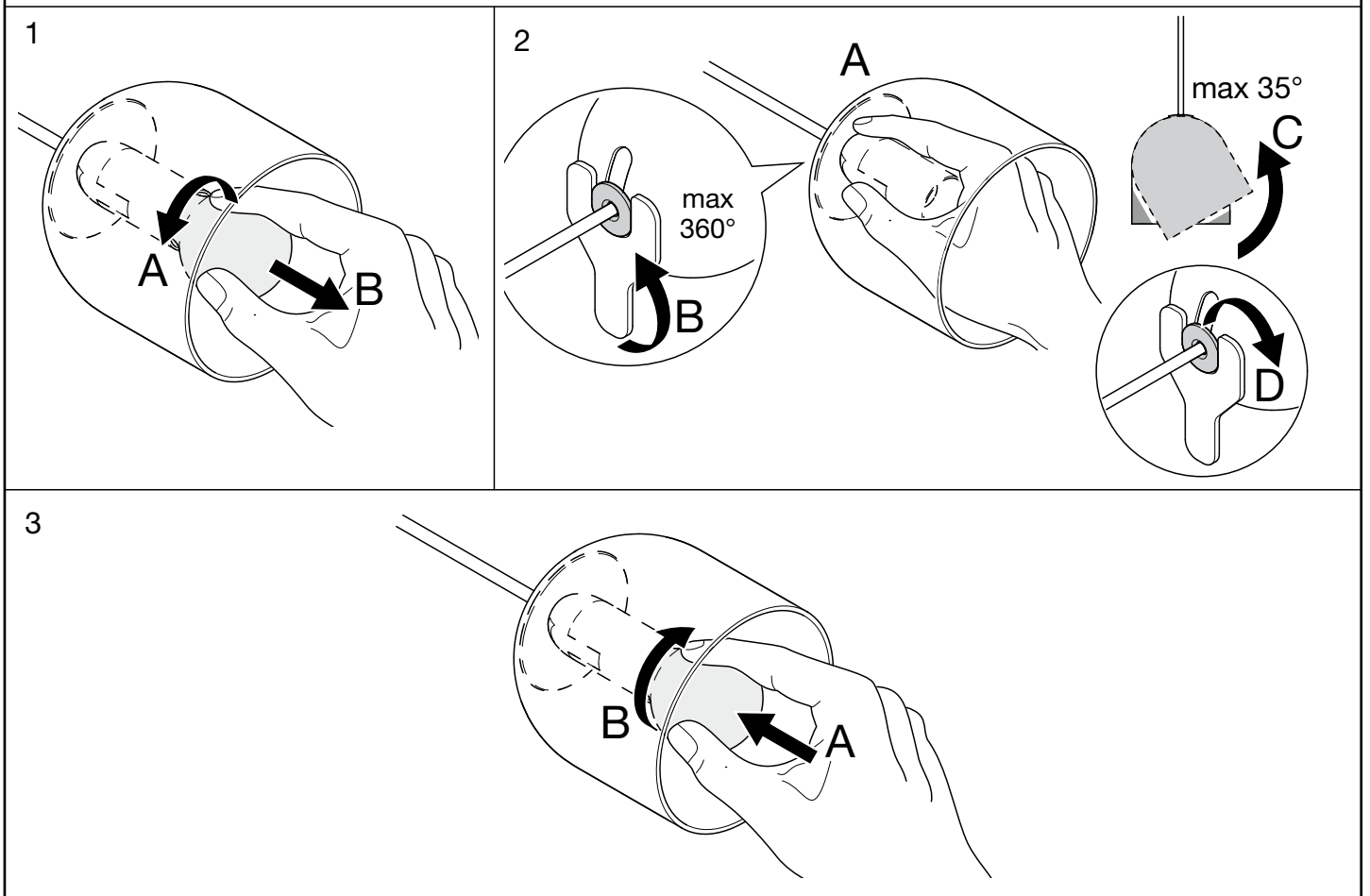

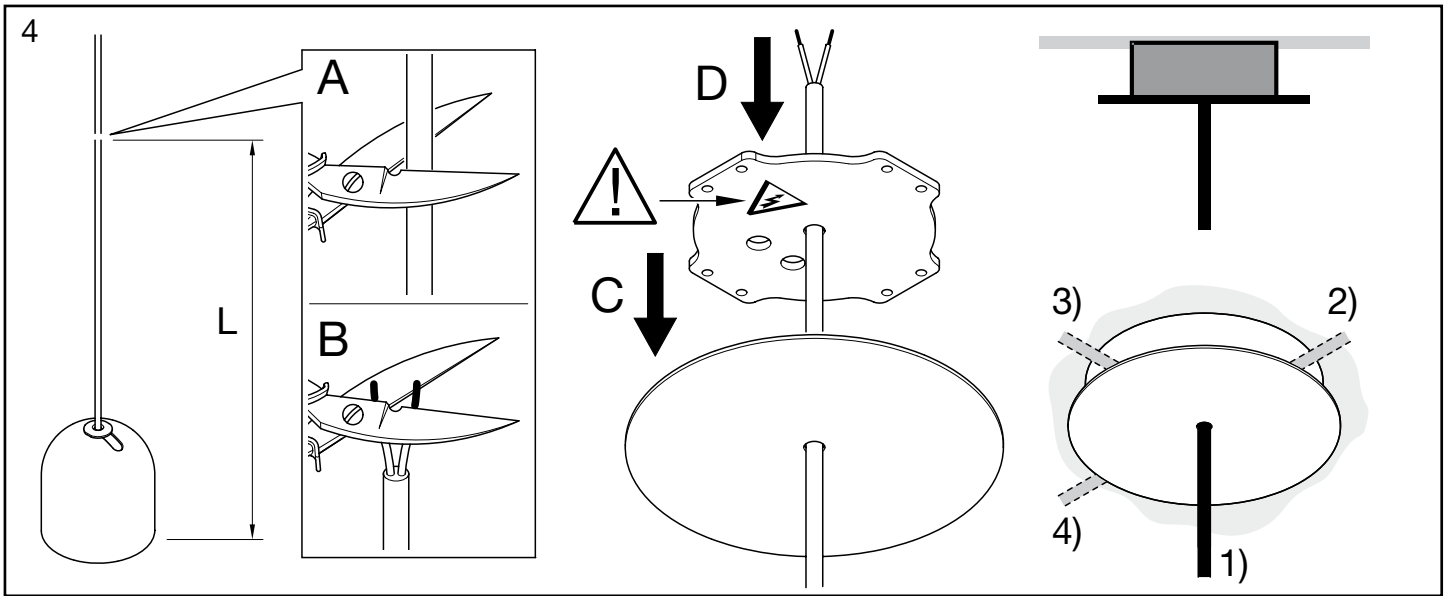

INSTALLAZIONE - INSTALLATION - INSTALLATION - INSTALLATION - INSTALACIÓN

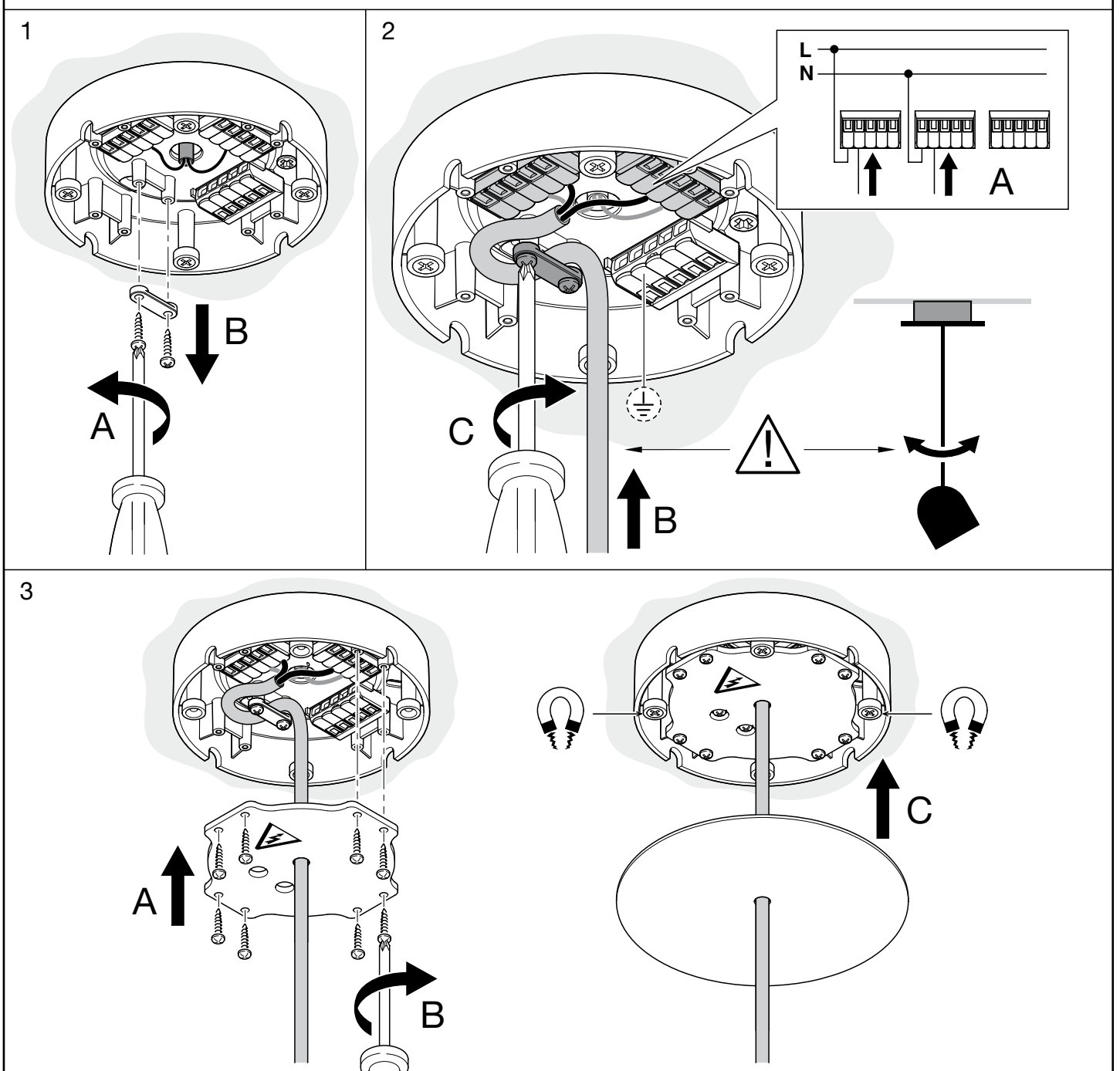

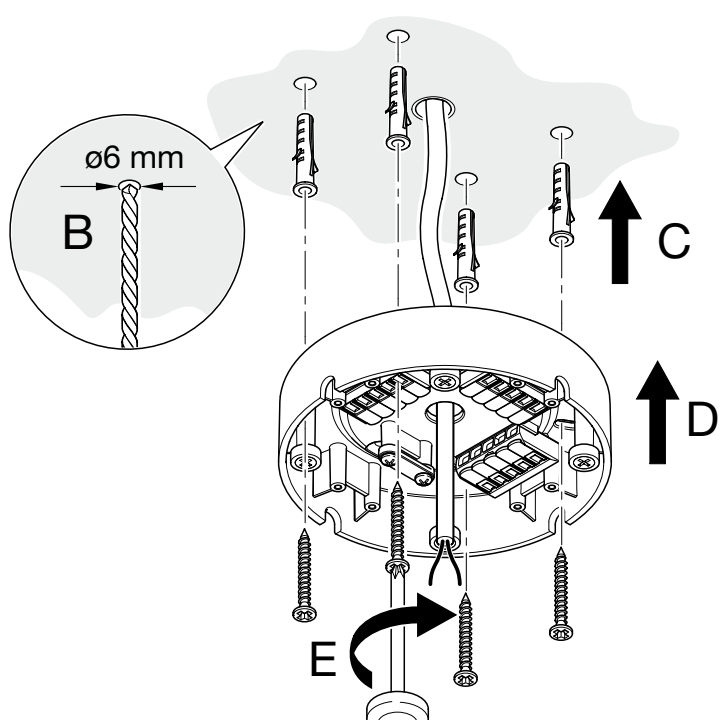
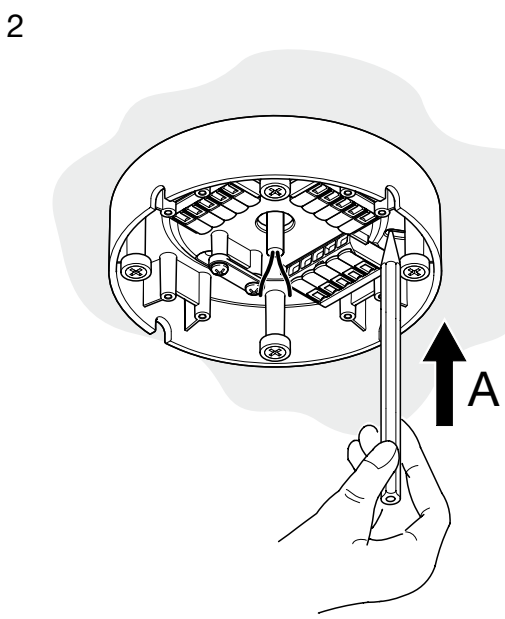
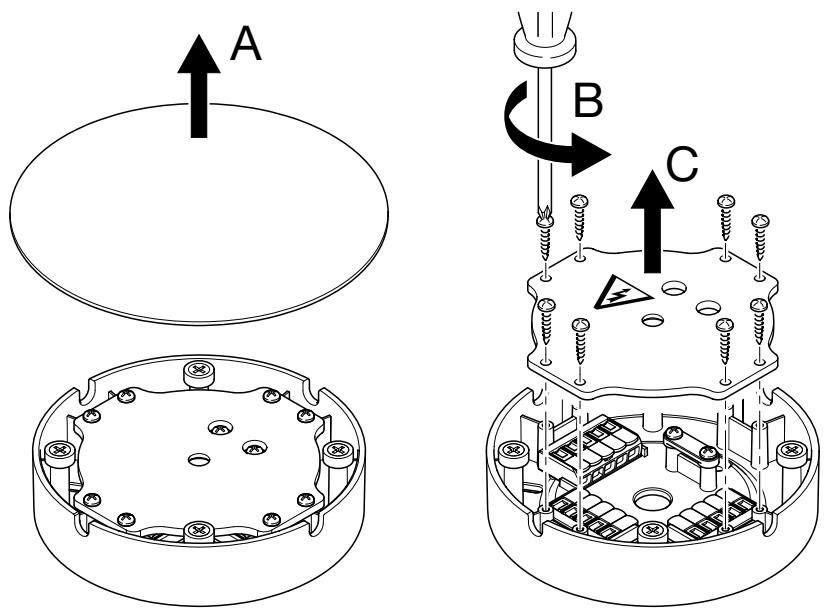
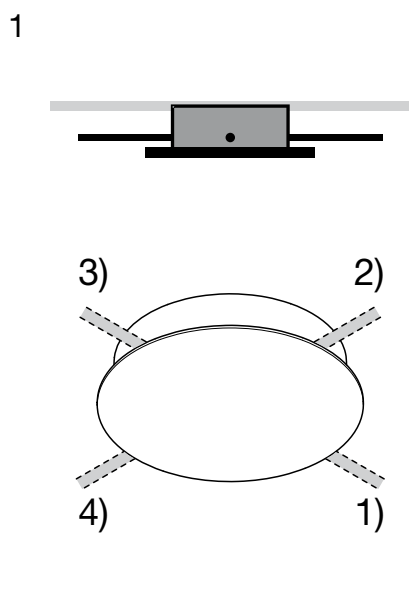
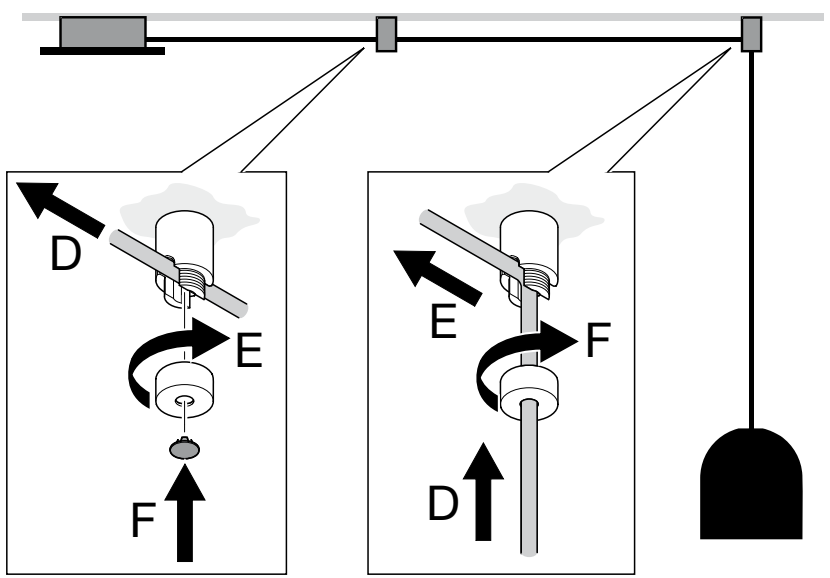
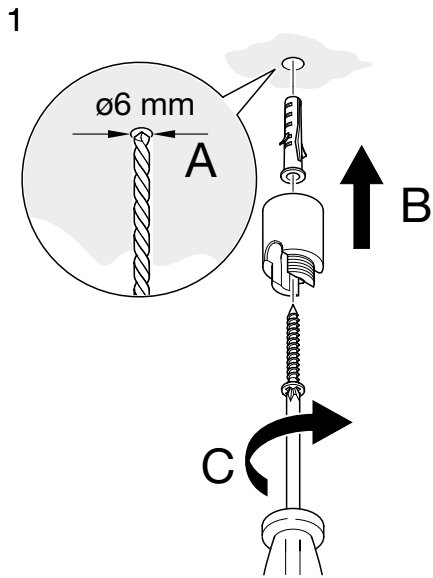

3

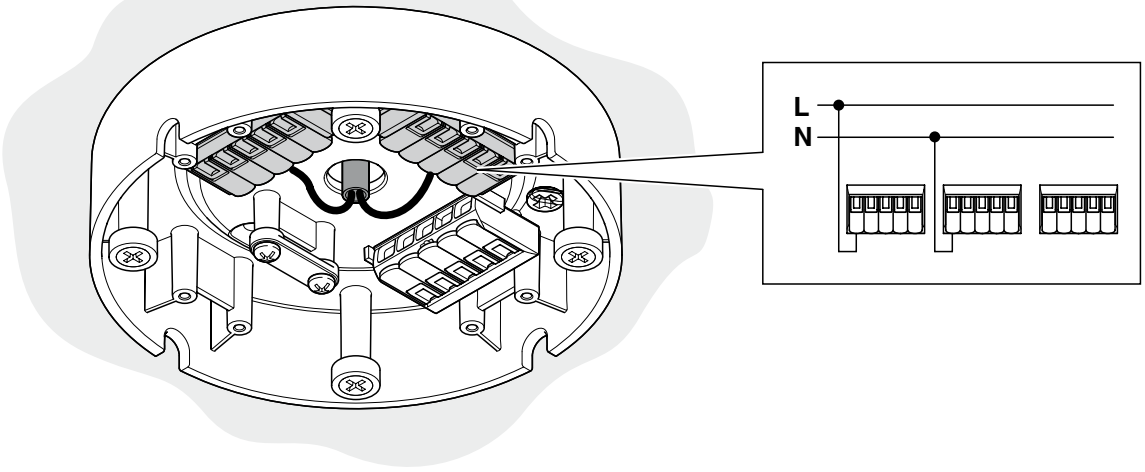

4

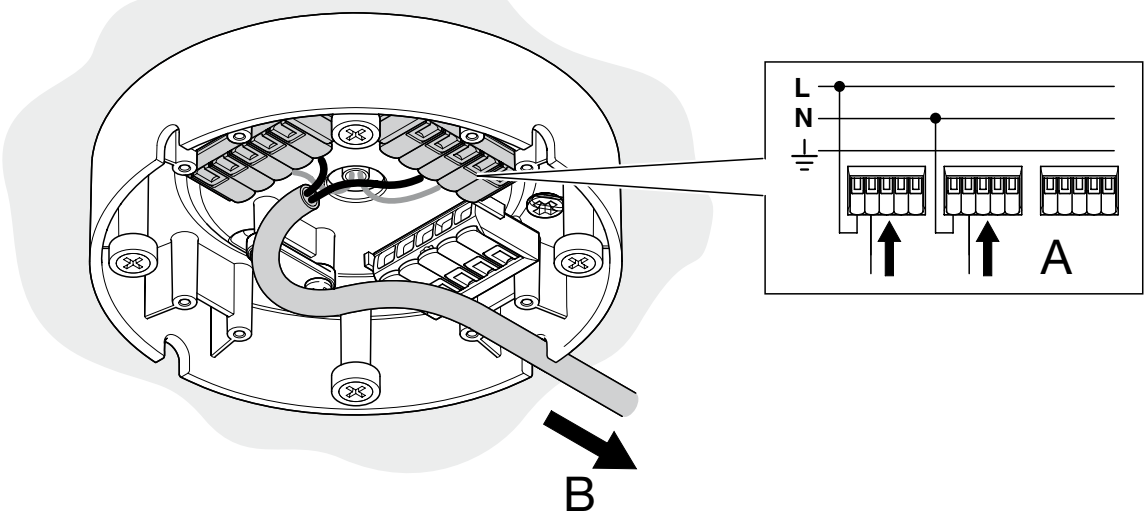

5

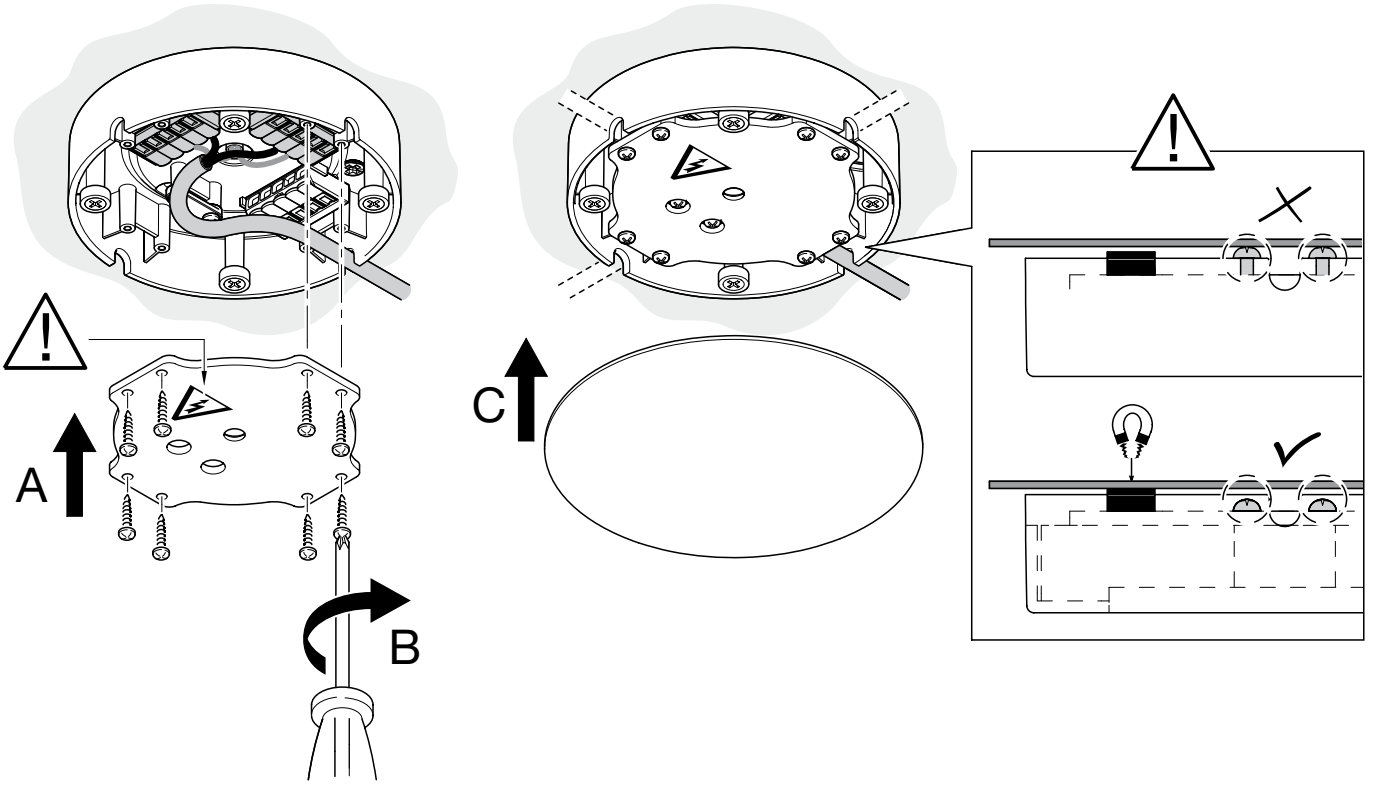

Garanzia

Tutti i prodotti Cini&Nils sono costruiti con materiali di prima qualità, sottoposti a severe procedure di collaudo e sono garantiti 2 anni da difetti di fabbricazione secondo la normativa vigente.

Guarantee

All Cini&Nils luminaries are produced with first-quality materials, undergo strict test procedure and are covered by a 2-year guarantee against production defects according to laws in force.

Garantie

Sämtliche Cini&Nils Produkte sind mit Materialien erstklassiger Qualität hergestellt, werden zu strengen Abnahmeprüfungen unterbreitet und haben zwei Jahre Garantie gegen Produktionsdefekte nach den bestehenden Gesetzen.



Garantie

Tous les produits Cini&Nils sont fabriqués avec des matériaux de première qualité, soumis à sévères procédures d'essai et sont garantis 2 ans, selon la normative en vigueur, contre défauts de fabrication.



Garantía

Todos los productos Cini&Nils están fabricados con materiales de primera calidad, sometidos a estrictos procedimientos de prueba y están cubiertos por una garantía de 2 años contra defectos de fabricación, según las normas vigentes.

Tutela dell'ambiente

 Onde tutelare l'ambiente, non  buttate l'apparecchio tra i normali rifiuti al termine della sua vita utile, ma portatelo presso i punti di raccolta specifici per questi rifiuti previsti dalla normativa vigente.

Protecting the environment

 To protect our environment,  please do not dispose of this luminaire together with ordinary refuse when its working life comes to an end. Provision has been made by law for special collection points for refuse of this kind: please take it to one of these. Thank you.

Umweltschutzhinweis

 Bitte geben Sie diese Leuchte am Ende ihrer Nutzungsdauer nicht in den Hausmüll, sondern liefern Sie bei einer gemäß den einschlägigen Bestimmungen geeigneten Recycling-Einrichtung ab.

Protection de l'environnement

 Afin de protéger l'environnement, ne jetez pas l'appareil dans les ordures normales à la fin de sa durée de vie utile; portez-le dans un des centres de collecte spécifiques prévus pour ces déchets par la réglementation en vigueur.

Tutela del ambiente

 Con el fin de tutelar el ambiente, no tire el aparato entre los desechos normales al final de su vida útil. Llévelo a un centro de recogida específico para este tipo de desechos previsto por las normativas vigentes.

Copyright © Cini&Nils Milano, Italia.

I testi e le immagini sono protetti da diritto d'autore. Riproduzione non autorizzata.

Copyright © by Cini&Nils Milan, Italy.

These texts and images are covered by copyright. All unauthorized reproduction is prohibited.

Copyright © Cini&Nils Mailand, Italien.

Alle Texte und Abbildungen sind urheberrechtlich geschützt. Keine unerlaubte Wiedergabe.

Copyright © Cini&Nils Milan, Italia.

Les textes et les images sont protégés par des droits d'auteur. Reproduction interdite.

Copyright © Cini&Nils Milán, Italia.

Los textos y las imágenes están protegidos por el derecho de autor. Reproducción no autorizada.

CINI&NILS

via Pizzigoni 3 - 24060 Villongo (BG)
T +39 02 3343071
info@cinienils.com www.cinienils.com